

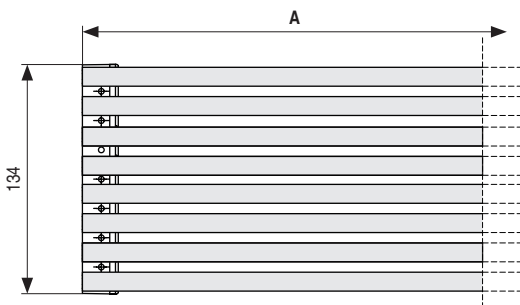

REVEN Rejilla de ventilación para horno

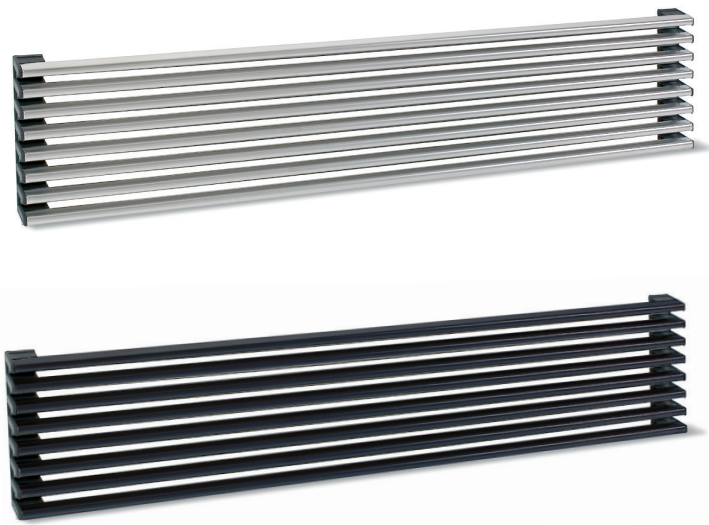

- Ajustable a sus necesidades.
- Se puede reducir en altura eliminando las varillas necesarias.
- Las varillas se pueden cortar a la medida deseada.

Acero inox.

CÓDIGO	A	N.º de varillas	Material	Acabado	
9036.84	600	8	acero inox.	mate	12
9036.87	900	8	acero inox.	mate	12

Aluminio

CÓDIGO	A	N.º de varillas	Material	Acabado	
9036.83	600	8	aluminio	mate	25
9036.85	600	8	aluminio	blanco	25
9036.86	600	8	aluminio	negro	25
9036.88	900	8	aluminio	blanco	25
9036.89	900	8	aluminio	negro	25

REJA Rejilla de aluminio estándar

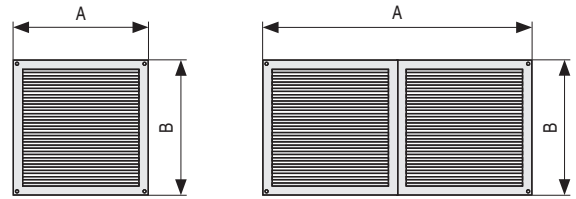
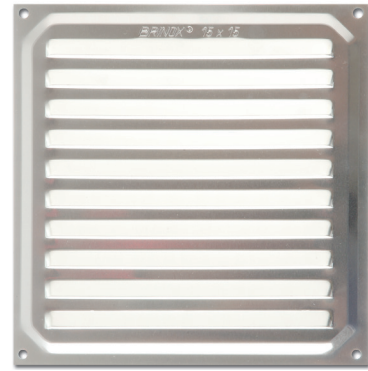

- Para fijación con tornillos.
- Disponible también con fijación adhesiva.
- Disponible en otros acabados, bajo pedido. Consultar.

CÓDIGO	Medida Ax B	Material	Acabado	
129.1	15x15	aluminio	natural	1
129.2	17x17	aluminio	natural	1
129.3	20x20	aluminio	natural	1
129.5	30x15	aluminio	natural	1

LEIRE Tope campana

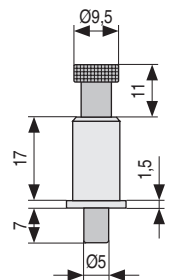
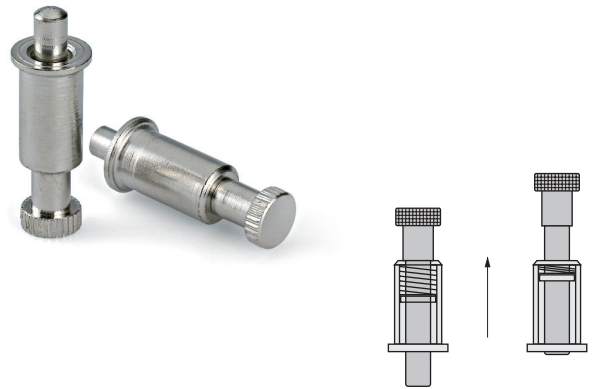

- Tope automático con muelle interior.

CÓDIGO	Material	Acabado	
494.1	acero	zincado	400